

A3 package: 750V 400A IGBT module

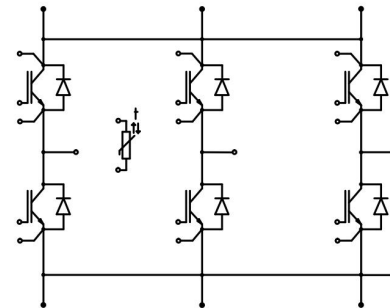
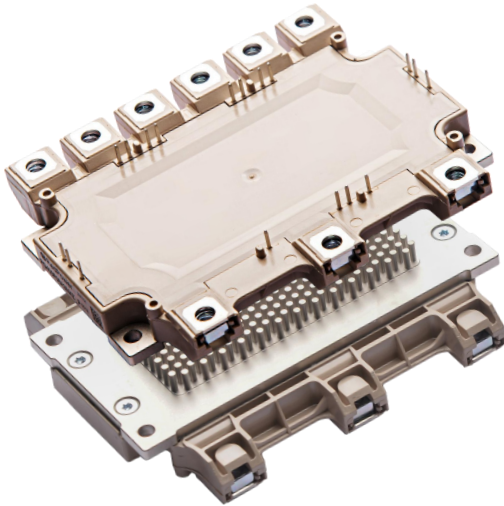

等效电路图

Equivalent Circuit Schematic

Features:

- 750V 400A, $V_{CE(sat)} = 1.35V @ 25^{\circ}C$
- High RBSOA capability
- Micro pattern trench/FS technology
- Low switching losses
- High SC capability

Typical Applications:

- Automotive Applications
- Motor Drives

产品特性:

- 750V 400A, $V_{CE(sat)} = 1.35V @ 25^{\circ}C$
- 高 RBSOA 能力
- 微沟槽/场终止技术
- 低开关损耗
- 高短路能力

典型应用:

- 汽车应用
- 电机驱动

IGBT, Inverter / IGBT, 逆变部分

Maximum Rated Values / 最大标称参数

Collector-emitter voltage 集电极-发射极电压	$T_{vj}=25^{\circ}\text{C}$	V_{CES}	750	V
Continuous DC collector current 集电极连续直流电流		$I_{C\text{ nom}}$	400	A
	$T_f=25^{\circ}\text{C}, T_{vj\text{ max}}=175^{\circ}\text{C}$	I_C	495	A
Repetitive peak collector current 集电极可重复峰值电流	$t_p=1\text{ms}$	I_{CRM}	800	A
Total power dissipation 功率损耗	$T_f=25^{\circ}\text{C}, T_{vj\text{ max}}=175^{\circ}\text{C}$	P_{tot}	955	W
Gate-emitter peak voltage 门极-发射极峰值电压		V_{GES}	± 20	V

Characteristic Values / 性能参数

min. typ. max.

Collector-emitter saturation voltage ¹⁾ 集电极-发射极饱和压降	$I_C=400\text{A}, V_{GE}=15\text{V}$	$T_{vj}=25^{\circ}\text{C}$ $T_{vj}=125^{\circ}\text{C}$ $T_{vj}=150^{\circ}\text{C}$	V_{CESat}	-	1.35 1.44 1.47	-	V
Gate threshold voltage 门极阈值电压	$V_{CE}=V_{GE}, I_C=4\text{mA}$		V_{GEth}	5.00	6.00	7.00	V
Gate charge 门极电荷	$V_{GE}=-8\text{V}/15\text{V}, V_{CE}=400\text{V}$		Q_G	-	2.46	-	μC
Internal gate resistor 内置门极电阻	$T_{vj}=25^{\circ}\text{C}$		R_{Gint}	-	1.19	-	Ω
Input capacitance 输入电容	$V_{CE}=25\text{V}, V_{GE}=0\text{V}, f=100\text{kHz}$	$T_{vj}=25^{\circ}\text{C}$	C_{ies}	-	61.6	-	nF
Reverse transfer capacitance 反向传输电容	$V_{CE}=25\text{V}, V_{GE}=0\text{V}, f=100\text{kHz}$	$T_{vj}=25^{\circ}\text{C}$	C_{res}	-	0.20	-	nF
Collector-emitter cut-off current 集电极-发射极关断漏电流	$V_{CE}=750\text{V}, V_{GE}=0\text{V}$	$T_{vj}=25^{\circ}\text{C}$	I_{CES}	-	-	0.1	mA
Gate-emitter leakage current 门极-发射极漏电流	$V_{CE}=0\text{V}, V_{GE}=20\text{V}$	$T_{vj}=25^{\circ}\text{C}$	I_{GES}	-	-	500	nA
Turn-on delay time, inductive load 开通延迟时间, 感性负载	$I_C=400\text{A}, V_{CE}=400\text{V}$ $V_{GE}=-8\text{V}/15\text{V}$ $R_{Gon}=1.3\Omega$	$T_{vj}=25^{\circ}\text{C}$ $T_{vj}=125^{\circ}\text{C}$ $T_{vj}=150^{\circ}\text{C}$	t_{don}	-	158 165 169	-	ns
Rise time, inductive load 上升时间, 感性负载	$I_C=400\text{A}, V_{CE}=400\text{V}$ $V_{GE}=-8\text{V}/15\text{V}$ $R_{Gon}=1.3\Omega$	$T_{vj}=25^{\circ}\text{C}$ $T_{vj}=125^{\circ}\text{C}$ $T_{vj}=150^{\circ}\text{C}$	t_r	-	49 58 59	-	ns
Turn-off delay time, inductive load 关断延迟时间, 感性负载	$I_C=400\text{A}, V_{CE}=400\text{V}$ $V_{GE}=-8\text{V}/15\text{V}$ $R_{Goff}=10\Omega$	$T_{vj}=25^{\circ}\text{C}$ $T_{vj}=125^{\circ}\text{C}$ $T_{vj}=150^{\circ}\text{C}$	t_{doff}	-	777 829 852	-	ns
Fall time, inductive load 下降时间, 感性负载	$I_C=400\text{A}, V_{CE}=400\text{V}$ $V_{GE}=-8\text{V}/15\text{V}$ $R_{Goff}=10\Omega$	$T_{vj}=25^{\circ}\text{C}$ $T_{vj}=125^{\circ}\text{C}$ $T_{vj}=150^{\circ}\text{C}$	t_f	-	72 85 95	-	ns
Turn-on energy loss per pulse 开通损耗	$I_C=400\text{A}, V_{CE}=400\text{V}, L_o=30\text{nH}$ $V_{GE}=-8\text{V}/15\text{V}, R_{Gon}=1.3\Omega$ $di/dt=5367\text{A}/\mu\text{s} (T_{vj}=150^{\circ}\text{C})$	$T_{vj}=25^{\circ}\text{C}$ $T_{vj}=125^{\circ}\text{C}$ $T_{vj}=150^{\circ}\text{C}$	E_{on}	-	8.4 11.8 12.0	-	mJ
Turn-off energy loss per pulse 关断损耗	$I_C=400\text{A}, V_{CE}=400\text{V}, L_o=30\text{nH}$ $V_{GE}=-8\text{V}/15\text{V}, R_{Goff}=10\Omega$ $dv/dt=4802\text{V}/\mu\text{s} (T_{vj}=150^{\circ}\text{C})$	$T_{vj}=25^{\circ}\text{C}$ $T_{vj}=125^{\circ}\text{C}$ $T_{vj}=150^{\circ}\text{C}$	E_{off}	-	20.9 25.1 26.4	-	mJ
SC data 短路耐量	$V_{CC}=400\text{V},$ $V_{GE}=-8\text{V}/15\text{V},$ $V_{CE\text{ max}}\leq 750\text{V}$	$t_p\leq 8\mu\text{s}, T_{vj}=25^{\circ}\text{C}$ $t_p\leq 6\mu\text{s}, T_{vj}=150^{\circ}\text{C}$	I_{sc}	-	3200 2200	-	A

Thermal resistance, junction to cooling fluid 结-冷却液热阻	Per IGBT, $\Delta V/\Delta t = 10.0 \text{ dm}^3/\text{min}$, $T_F=25^\circ\text{C}$	R_{thJF}	-	0.157	-	KW
Temperature under switching conditions 工作温度	t_{op} continuous	$T_{vj op}$	-40	-	150	$^\circ\text{C}$

Diode, Inverter / 二极管, 逆变部分

Maximum Rated Values / 最大标称参数

Repetitive peak reverse voltage 可重复反向峰值电压	$T_{vj}=25^\circ\text{C}$	V_{RRM}	750	V
Continuous DC forward current 可连续正向直流电流		I_{Fnom}	400	A
Repetitive peak forward current 可重复正向峰值电流	$I_{FRM}=2 \times I_F$	I_{FRM}	800	A

Characteristic Values / 性能参数

			min.	typ.	max.		
Forward voltage ¹⁾ 正向通态压降	$I_F=400\text{A}$, $V_{GE}=0\text{V}$	$T_{vj}=25^\circ\text{C}$ $T_{vj}=125^\circ\text{C}$ $T_{vj}=150^\circ\text{C}$	V_F	-	1.45 1.42 1.40	-	V
Peak reverse recovery current 反向恢复峰值电流	$I_F=400\text{A}$, $V_R=400\text{V}$, $V_{GE}=-8\text{V}$, $-di_F/dt=3174\text{A}/\mu\text{s}(T_{vj}=150^\circ\text{C})$	$T_{vj}=25^\circ\text{C}$ $T_{vj}=125^\circ\text{C}$ $T_{vj}=150^\circ\text{C}$	I_{RM}	-	262 300 311	-	A
Recovery charge 反向恢复电荷	$I_F=400\text{A}$, $V_R=400\text{V}$, $V_{GE}=-8\text{V}$, $-di_F/dt=3174\text{A}/\mu\text{s}(T_{vj}=150^\circ\text{C})$	$T_{vj}=25^\circ\text{C}$ $T_{vj}=125^\circ\text{C}$ $T_{vj}=150^\circ\text{C}$	Q_R	-	20.4 32.6 36.5	-	μC
Reverse recovery energy 反向恢复损耗	$I_F=400\text{A}$, $V_R=400\text{V}$, $V_{GE}=-8\text{V}$, $-di_F/dt=3174\text{A}/\mu\text{s}(T_{vj}=150^\circ\text{C})$	$T_{vj}=25^\circ\text{C}$ $T_{vj}=125^\circ\text{C}$ $T_{vj}=150^\circ\text{C}$	E_{rec}	-	5.9 9.7 11.3	-	mJ
Thermal resistance, junction to cooling fluid 结-冷却液热阻	Per FRD $\Delta V/\Delta t = 10.0 \text{ dm}^3/\text{min}$, $T_F=25^\circ\text{C}$		R_{thJF}	-	0.24	-	KW
Temperature under switching conditions 工作温度	t_{op} continuous		$T_{vj op}$	-40	-	150	$^\circ\text{C}$

NTC-Thermistor/ NTC-热敏电阻

Characteristic Values / 性能参数

			min.	typ.	max.	
Rated resistance 标称电阻	$T_{NTC}=25^\circ\text{C}$	R_{25}	-	5	-	K Ω
Deviation of R100 R100 偏移值	$T_{NTC}=100^\circ\text{C}$, $R_{100}=493.3\Omega$	$\Delta R/R$	-5	-	5	%
Power dissipation 功率耗散	$T_{NTC}=25^\circ\text{C}$	P_{25}	-	-	20	mW
B-value B 值	$R_2=R_{25} \exp[B_{25/50}(1/T_2-1/(298.15\text{K}))]$	$B_{25/50}$	-	3375	-	K
	$R_2=R_{25} \exp[B_{25/80}(1/T_2-1/(298.15\text{K}))]$	$B_{25/80}$	-	3414	-	K
	$R_2=R_{25} \exp[B_{25/100}(1/T_2-1/(298.15\text{K}))]$	$B_{25/100}$	-	3436	-	K

Module / 模块
Insulation coordination / 绝缘配合

Isolation test voltage 绝缘测试电压	RMS, f=50Hz, t=1min	V_{ISOL}	3	KV
Material of module baseplate 模块底板材料			Cu	
Internal isolation 内部绝缘			ZTA	
Creepage distance 爬电距离	Terminal to heatsink Terminal to terminal		12.0 6.1	mm
Clearance 电气间隙	Terminal to heatsink Terminal to terminal		12.0 6.1	mm
Comparative tracking index 相对漏电起痕指数		CTI	200 ²⁾	

		min.		typ.		max.	
Stray inductance module 模块杂散电感		L_{sCE}	-	13	-	-	nH
Module lead resistance, terminals- chip 模块引脚电阻, 端子-芯片	T=25°C, Per Switch	$R_{CC'+EE'}$	-	1.0	-	-	mΩ
Storage temperature 贮存温度		T_{stg}	-40	-	125	-	°C
Mounting torque for module mounting 模块安装力矩	Screw M5 / M5 螺丝 Baseplate to heatsink	M	3.0	-	6.0	-	Nm
Terminal connection torque 功率端子连接力矩	Screw M6 / M6 螺丝	M	4.0	-	6.0	-	Nm
Weight 重量		G	-	680	-	-	g

- 1) Terminal impedance is included.
包含端子阻抗。
- 2) CTI is about 200.
CTI 约等于 200。

Circuit Diagram / 曲线图

Output characteristic IGBT, Inverter (typical), Inclusive R_{CC+EE}
IGBT 输出特性, 逆变 (典型值), 包含 R_{CC+EE}
 $I_c = f(V_{CE}), V_{GE} = 15V$

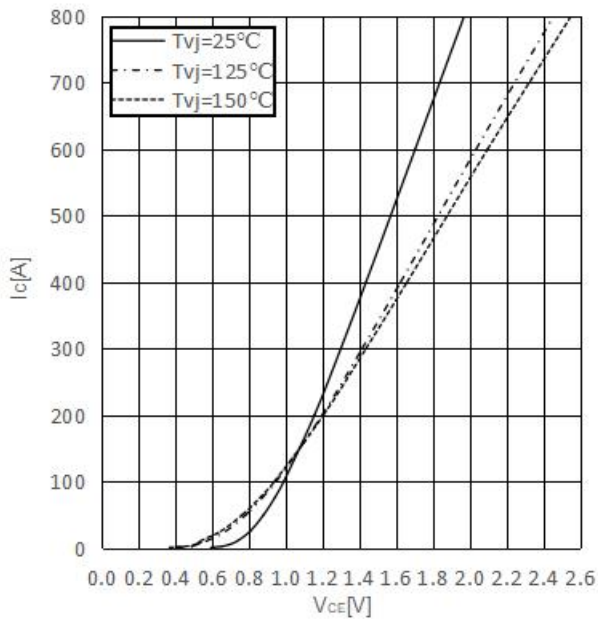

Output characteristic IGBT, Inverter (typical), Inclusive R_{CC+EE}
IGBT 输出特性, 逆变 (典型值), 包含 R_{CC+EE}
 $I_c = f(V_{CE}), T_{vj} = 150^\circ C$

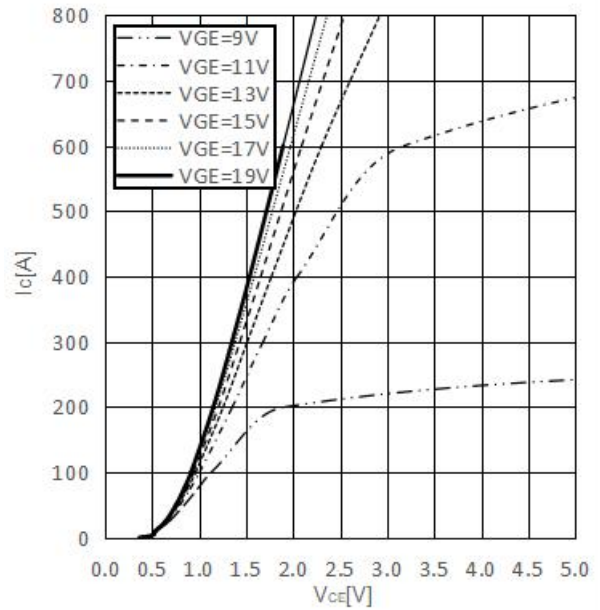

Transfer characteristic IGBT, Inverter (typical), Inclusive R_{CC+EE}
IGBT 传输特性, 逆变 (典型值), 包含 R_{CC+EE}
 $I_c = f(V_{GE}), V_{CE} = 20V$

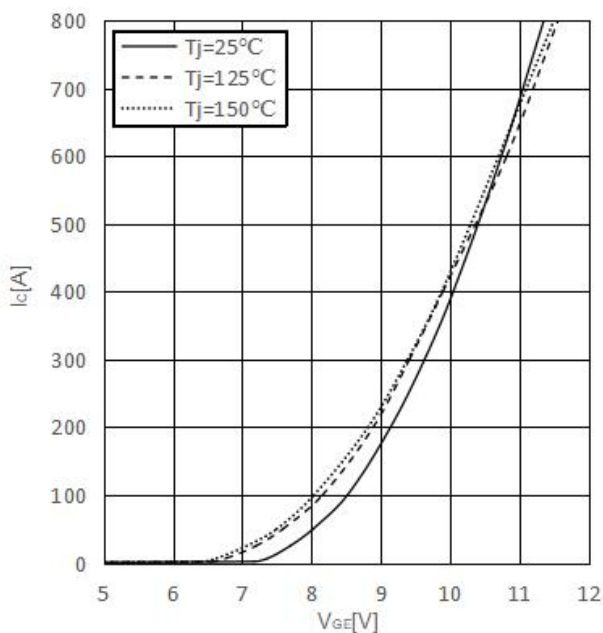

Switching losses IGBT, Inverter (typical), Inclusive R_{CC+EE}
IGBT 开关损耗, 逆变 (典型值), 包含 R_{CC+EE}
 $E = f(I_c), V_{GE} = +15V/-8V,$
 $R_{Gon} = 1.3\Omega, R_{Goff} = 10\Omega, V_{CE} = 400V$

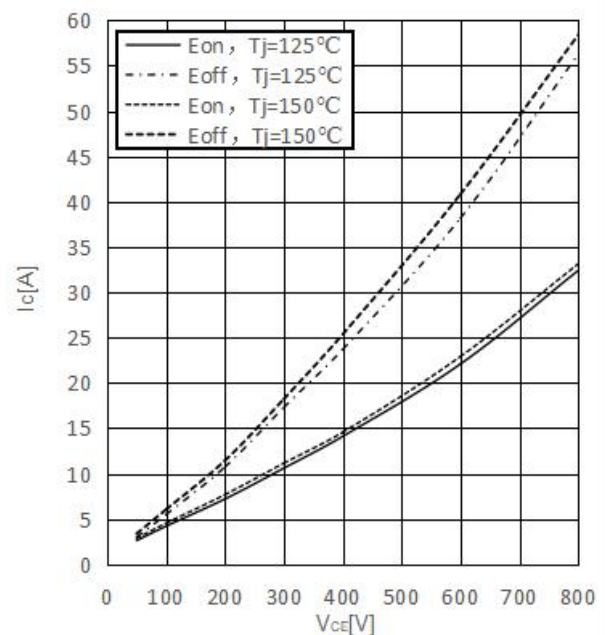

Switching losses IGBT, Inverter (typical), Inclusive R_{CC+EE}
IGBT 开关损耗, 逆变 (典型值), 包含 R_{CC+EE}
 $E=f(R_G), V_{GE}=+15V/-8V, I_C=400A, V_{CE}=400V$

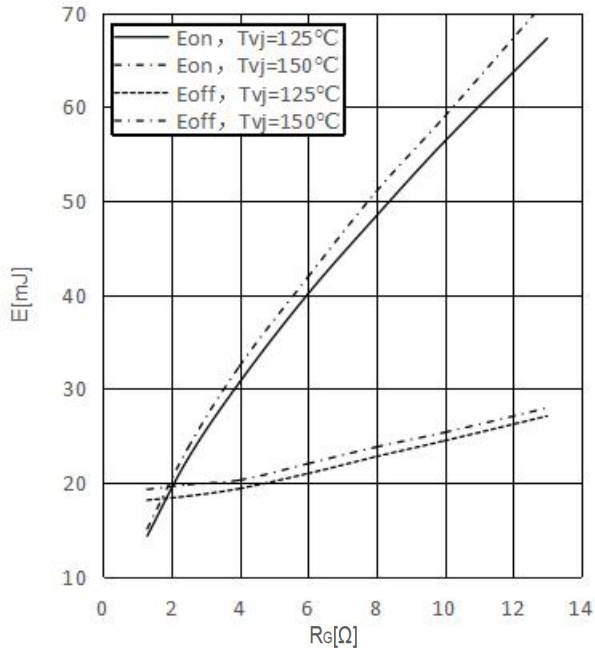

Transient thermal impedance IGBT, Inverter
IGBT 瞬态热阻, 逆变
 $Z_{thJF}=f(t)$
 $\Delta V/\Delta t = 10.0 \text{ dm}^3/\text{min}, T_F=25^\circ\text{C}, \text{ pure water}$

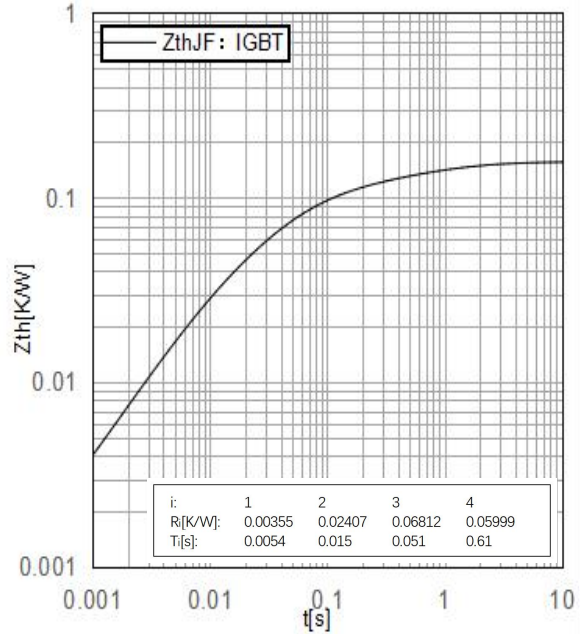

Reverse bias safe operating area IGBT, Inverter (RBSOA)
IGBT 反向安全工作区, 逆变 (RBSOA)
 $I_C=f(V_{CE}), V_{GE}=+15V/-8V, R_{Goff} = 10\Omega, T_J = 150^\circ\text{C}$

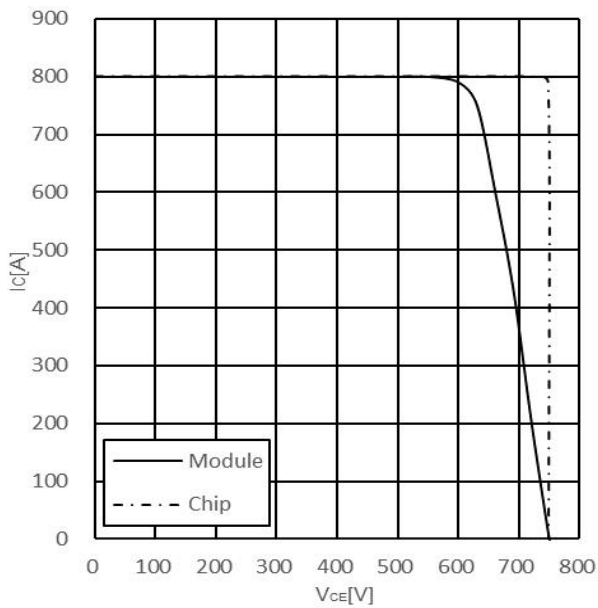

Forward characteristic FRD, Inverter (typical), Inclusive R_{CC+EE}
FRD 正向特性, 逆变 (典型值), 包含 R_{CC+EE}
 $I_F=f(V_F)$

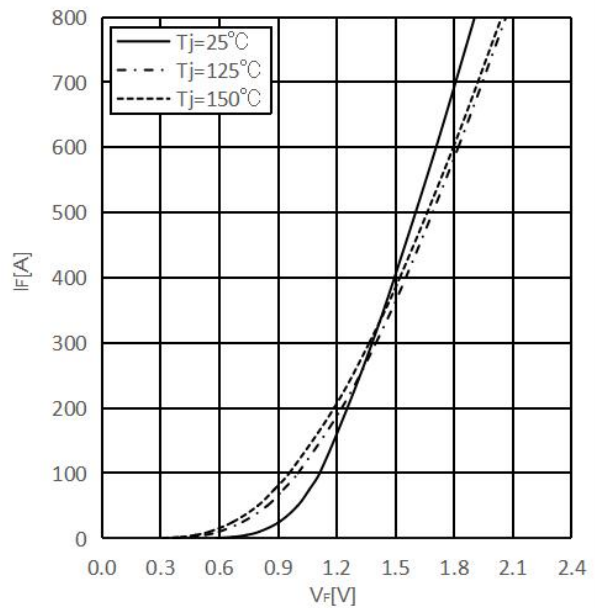

Switching Losses FRD, Inverter (typical),

Inclusive $R_{CC}+EE'$

FRD 开关损耗, 逆变 (典型值), 包含 $R_{CC}+EE'$

$E_{rec}=f(I_F), R_{Gon}=1.3\Omega, V_{CE}=400V$

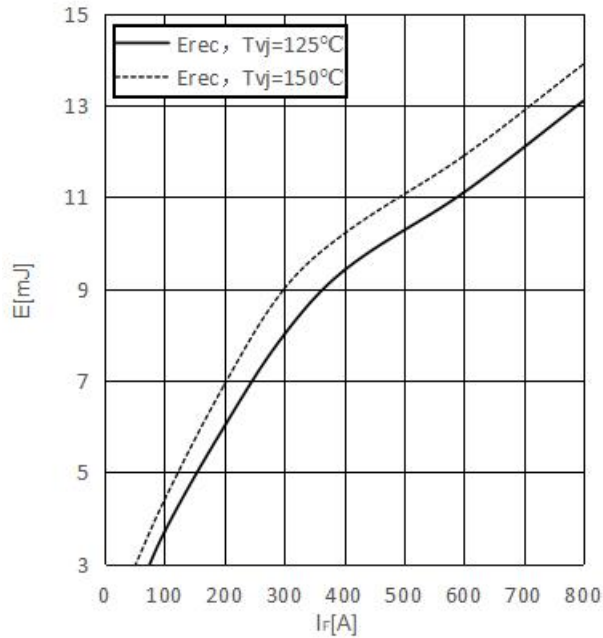

Output characteristic E_{rec} , Inverter (typical),

Inclusive $R_{CC}+EE'$

FRD 输出特性, 逆变 (典型值), 包含 $R_{CC}+EE'$

$E_{rec}=f(R_g)$

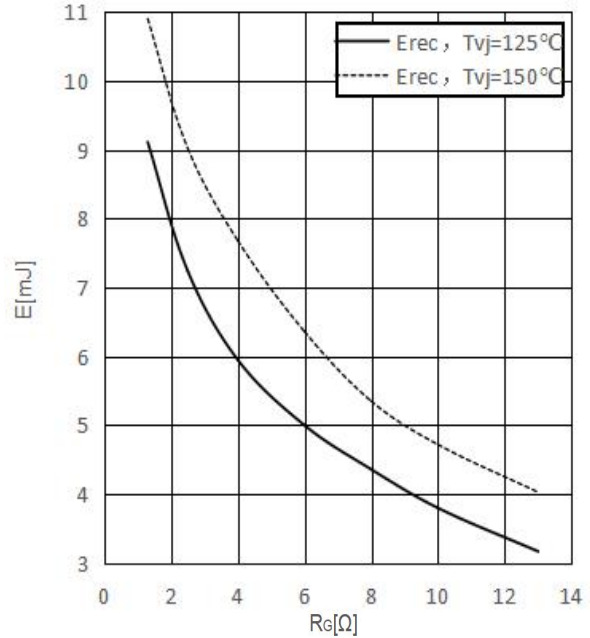

Transient thermal impedance FRD, Inverter

FRD 瞬态热阻, 逆变

$Z_{thJF}=f(t)$

$\Delta V/\Delta t = 10.0 \text{ dm}^3/\text{min}, T_F=25^\circ\text{C}, \text{ pure water}$

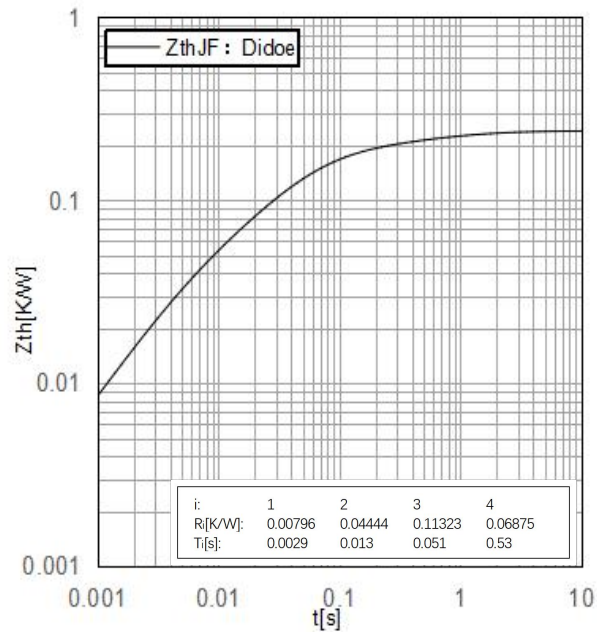

NTC Thermistor temperature characteristic (typical)

NTC 热敏电阻

$R=f(T)$

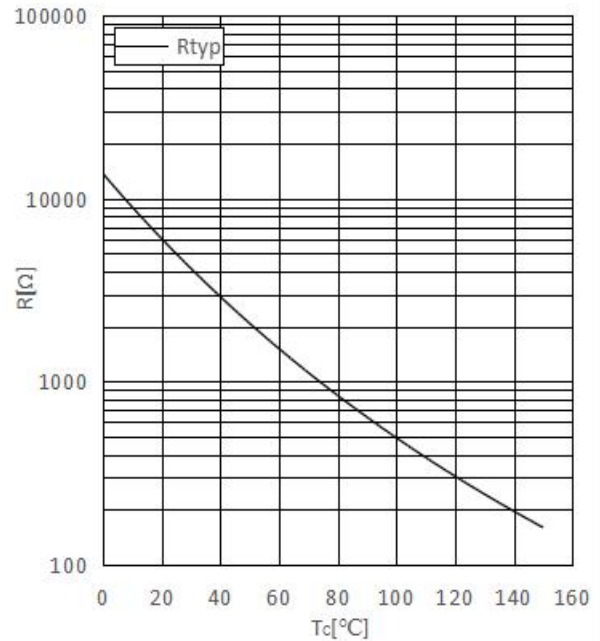

Package Dimension / 封装尺寸

Dimensions in Millimeters / 毫米为单位

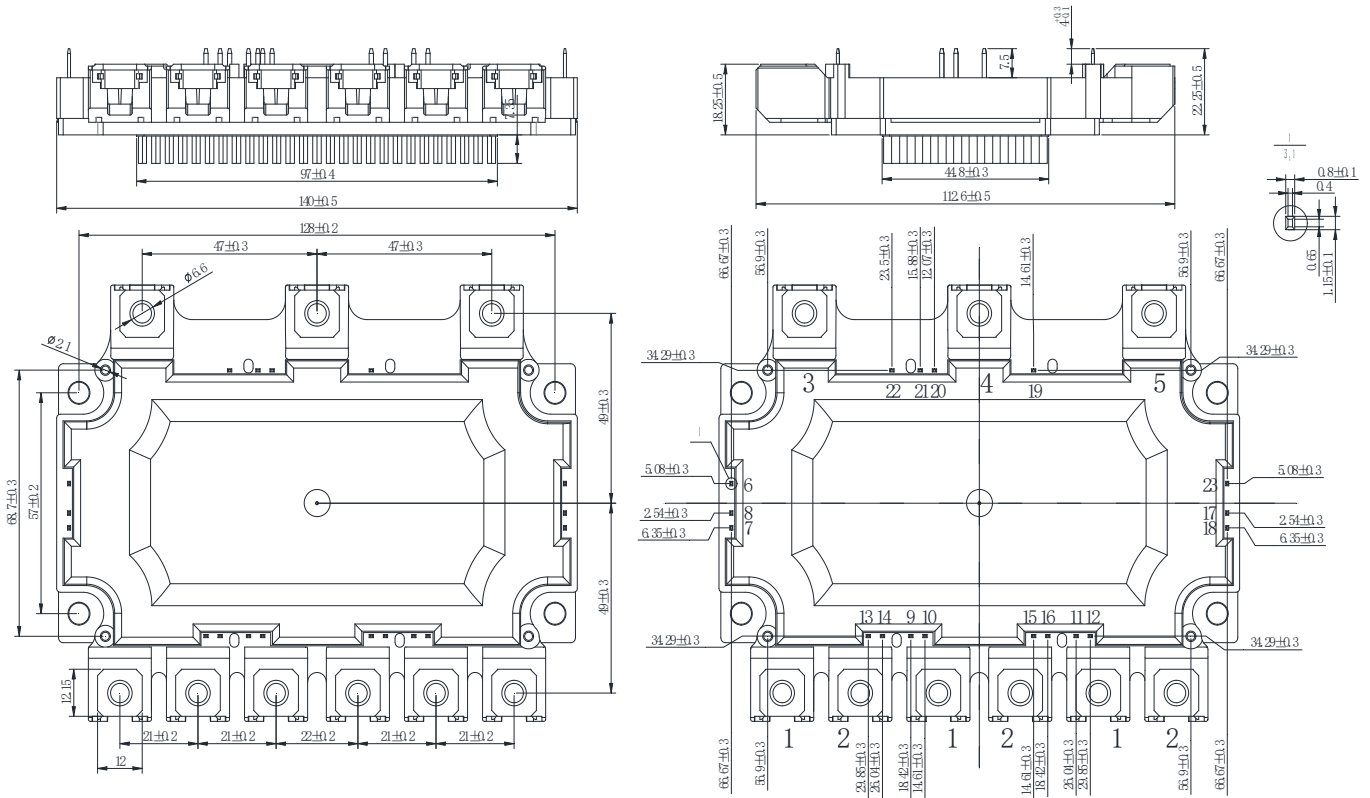

Internal Circuit / 内部电路

